

FLOOR-EVEN SHOWERS
AND BATHTUBS

CLEVER IDEAS FOR **BETTER** **BATHROOMS**

**KNOW
HOW**
INSTALLED

CONTENTS

04

SHOWER SURFACES: GEBERIT SETAPLANO, SESTRA AND OLONA, TOOL-FREE INSTALLATION TECHNOLOGY

For floor-even, barrier-free showers that are visually clearly separate from the bathroom floor.



16

NEMEA SHOWER SURFACE

Floor-even acrylic shower surface. A cost-effective and elegant solution for every bathroom

18

SHOWER DRAINS: GEBERIT CLEANLINE SHOWER CHANNELS

The easy-to-clean shower channel without hidden areas. Narrow and functional: The new Geberit CleanLine50 shower channel.



22

SHOWER DRAINS: GEBERIT WALL AND FLOOR DRAIN

For drainage of completely tiled shower areas.

28

CLEVER USE OF PREWALL INSTALLATION

The Geberit niche storage box and the walk-in shower panel with invisible fastenings optimally use the possibilities provided by a prewall installation.

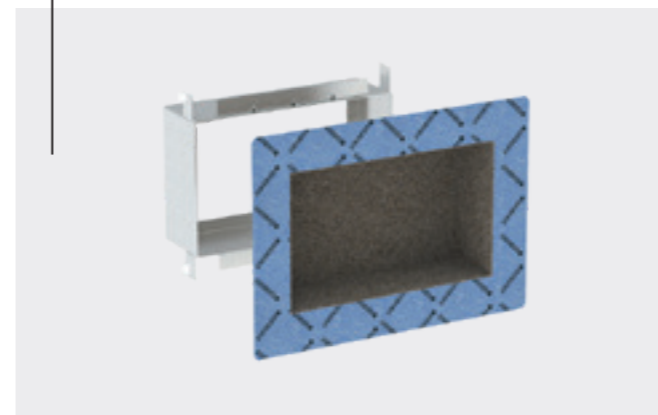

38

NEW BATHTUB DRAINS

New drain assemblies with turn handle – with and without inlet. Available in four different colour variations.

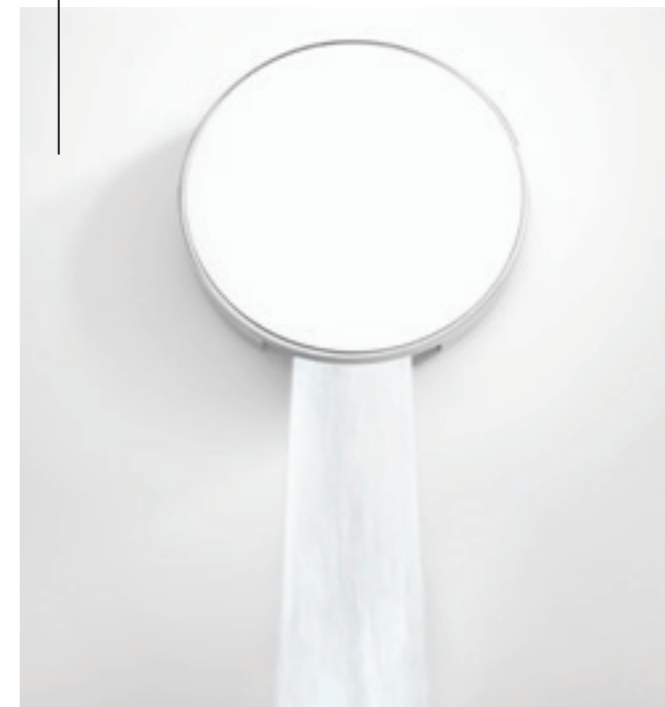



The Geberit Setaplano shower surface is a captivating product from the very first glance – and the very first touch. Made of a high-quality solid surface material, it has a surface that feels silky-smooth and warm to the touch.



Floor-even entry



Consistent room design



Silky-smooth surface that is pleasant and warm to the touch



Easy cleaning and care



GEBERIT SETAPLANO SHOWER SURFACE

PRECISE RELIABILITY

- High-quality solid surface material with the best antislip class C in accordance with DIN 51097.
- Drain positioned at the side for maximum free space without backwater.
- Available in various sizes and formats.



SOPHISTICATED DESIGN

Not only is the Geberit Setaplano shower surface easy to install, it also offers tangible added value to the user. The solid surface material is highly resistant and non-porous, making it easy to clean.

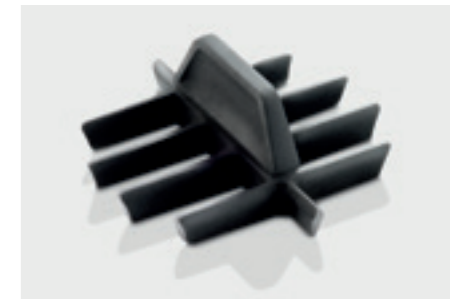

CLEAN DRAINS

The drain area has been deliberately designed without edges where dirt can collect. What makes the shower surface especially easy to clean is the practical comb insert, which can be removed easily and cleaned as required.

GEBERIT SETAPLANO SHOWER SURFACES ARE AVAILABLE IN 22 DIFFERENT DESIGNS

SQUARE DESIGN

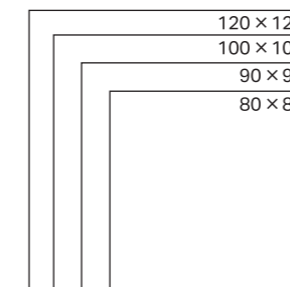

RECTANGULAR DESIGN

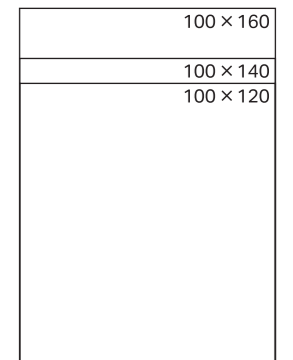
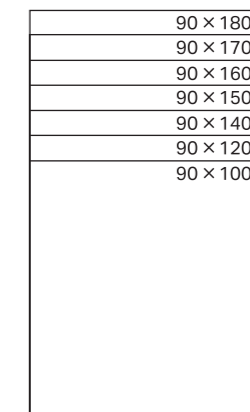
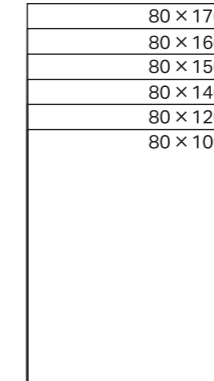
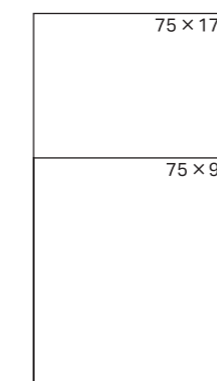

GEBERIT SETAPLANO SHOWER SURFACE

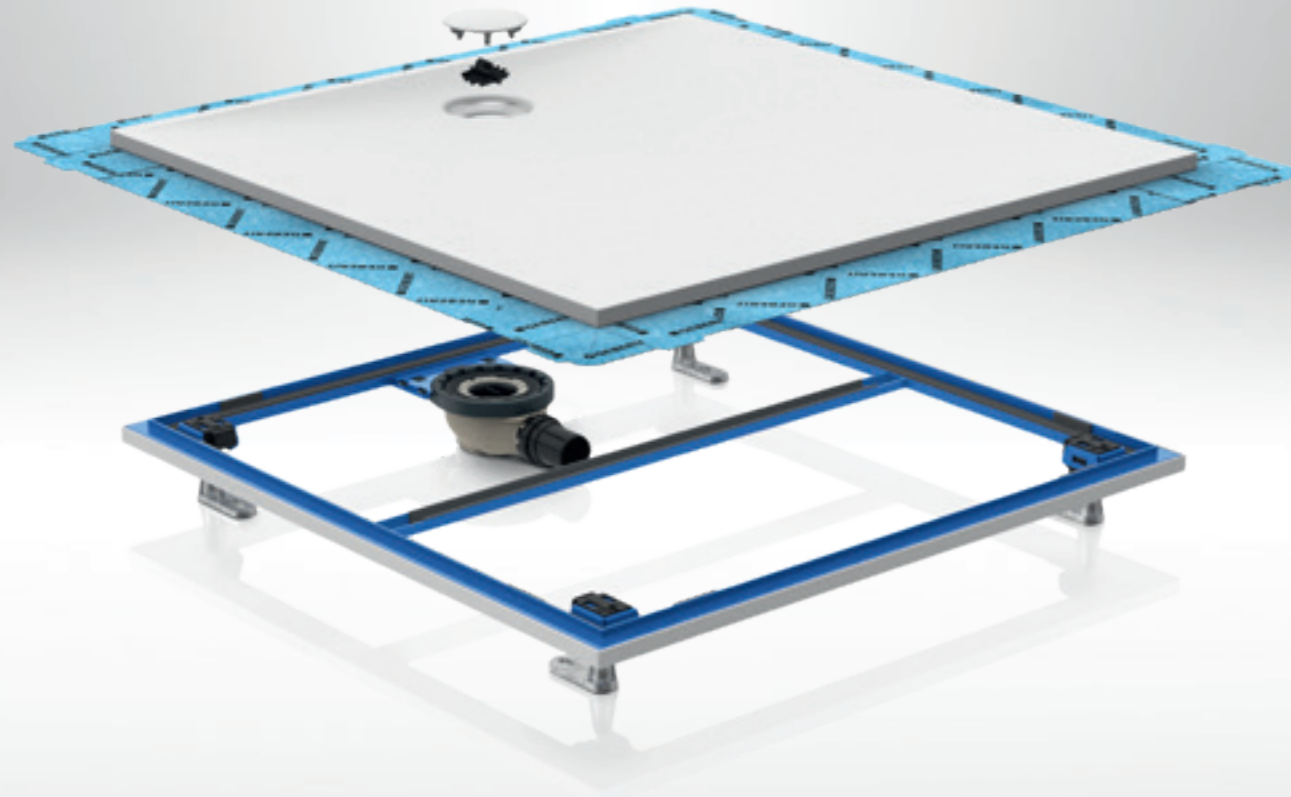

- Stable installation frame made of powder-coated steel for easy installation.
- Feet can be clicked into the frame in no time.
- Precise trap placement thanks to integrated bracket.
- Convenient height adjustment from above.

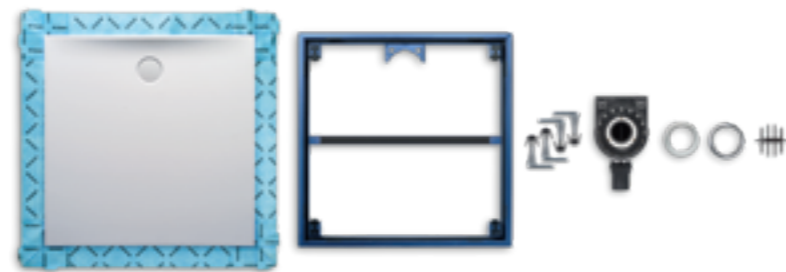
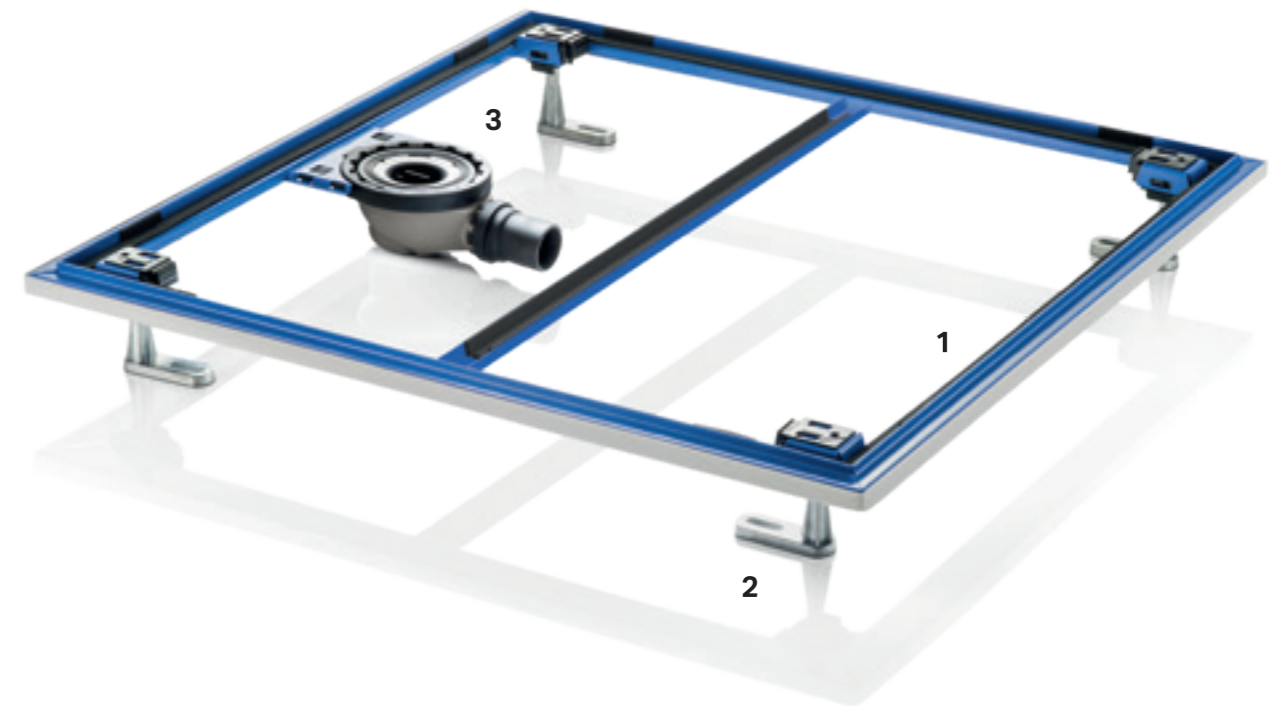

- With the Geberit Setaplano shower surface, the number of individual parts required for installation is kept to a minimum.
- As the sealing fleece comes premounted at the factory, the work is made significantly simpler and a high level of safety is ensured.



STABLE AND SUITABLE FOR BUILDING SITES

The distinctive blue installation frame, made of powder-coated steel, is available in a range of sizes. Four to six feet are required for installation, depending on the size. The feet are simply clicked into place on the frame at the designated points.



SIMPLE ALIGNMENT - SECURE FASTENING

The feet can be aligned easily with the floor height using a standard tool, working from above. Once this is complete, sliders are used to secure them reliably in place.



EASY-TO-INSTALL TRAP

The trap is available in two models: one with a 3 cm depth of water seal and a discharge rate of 0.45 l/s, and one with a 5 cm depth of water seal and a discharge rate of 0.65 l/s. Both models can be snapped into the premounted bracket and aligned by rotating 360°. Simple cleaning: the flexible trap cup can be removed as a whole part.



The look of the Geberit Olona shower surface is just as stunning as its functions. A slim chrome ring surrounds the shower surface drain cover to provide a delicate accent.



New surface design made of matt white resin stone



Steady footing thanks to antislip class B



Surface-even or lay-on installation possible

GEBERIT OLONA SHOWER SURFACE

ELEGANCE WITHOUT COMPROMISE

- New floor-even shower surface made of resin stone
- Matt white surface
- Available in 26 different formats
- Easy installation



SPECIAL DRAIN COVER
Design drain cover included in the Olona shower surface scope of delivery.



SEALING FLEECE
The shower surface is equipped with a circumferential sealing fleece at the factory.

GEBERIT OLONA SHAPES AND SIZES

SQUARE DESIGN



RECTANGULAR DESIGN

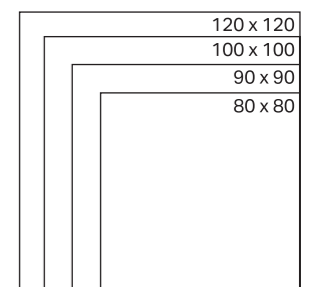

70 x 170
70 x 160
70 x 140
70 x 120
70 x 100
70 x 90

75 x 170
75 x 90

80 x 170
80 x 160
80 x 140
80 x 120
80 x 100

90 x 180
90 x 170
90 x 160
90 x 140
90 x 120
90 x 100

100 x 160
100 x 140
100 x 120

Geberit Sestra shower solution has a stone-structure look and feel, which goes perfectly with textured, matt tiles. Available in white, stone grey or graphite, it can be incorporated in combination with various different bathroom styles. The structured surface is also suitable for use in barrier-free and age-appropriate bathrooms on account of its antislip properties. The drain solution is designed to suit the shower channels in the Geberit CleanLine series.



Unique and elegant surface with visible and tangible stone effect.



Reliable antislip properties.



Shower channel with minimal hidden areas for simple cleaning.

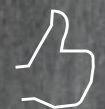

Surface-even or lay-on installation possible.

GEBERIT SESTRA SHOWER TRAY

WHEN FORM AND FUNCTION COME TOGETHER



- Available in rectangular and square versions in 16 formats
- Three design options: white, stone grey, graphite
- Surface with the best antislip class C in accordance with DIN 51097

THREE NATURAL COLOURS

The Geberit Sestra shower tray is available in three colours that work in perfect harmony with the slate structure of the surface: white, stone grey and graphite.



REMOVABLE COMB INSERT

An easy-to-clean, removable comb insert positioned underneath the drain cover prevents clogging in the drainage system.

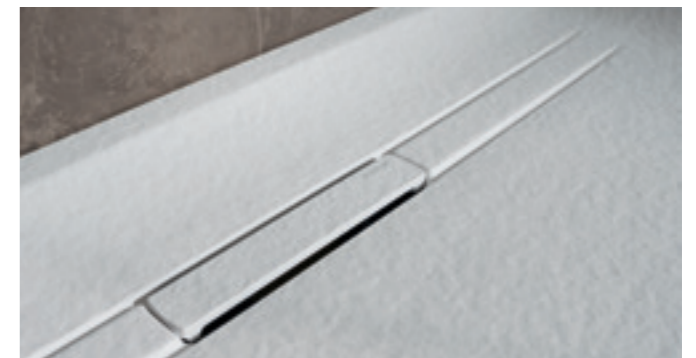

DRAIN WITHOUT EXTENSIVE HIDDEN AREAS

Water is guided via a surface profile with no hidden areas to the drain in the middle of the integrated shower channel.

GEBERIT SESTRA SHOWER TRAYS ARE AVAILABLE IN 16 DIFFERENT DESIGNS

SQUARE DESIGN

90 × 90
80 × 80

RECTANGULAR DESIGN

90 × 160
90 × 140
90 × 120
90 × 100

80 × 160
80 × 140
80 × 120
80 × 100

70 × 170
70 × 160
70 × 140
70 × 120
70 × 100
70 × 90

SHOWER TRAY FEET FOR GEBERIT OLONA,
SESTRA AND MELUA

TOOL-FREE INSTALLATION AND HEIGHT ADJUSTMENT

- Installation without solid construction
- Tool-free installation
- Easy to adhere to resin stone shower surfaces
- Versatile product design for bathroom and sanitary installation
- Available in two sizes: height adjustment from 6 to 12 cm or 9 to 21 cm

THE NEW SET OF FEET THAT CAN BE INSTALLED WITHOUT TOOLS

makes it easier to install Geberit Olona, Sestra and Melua shower surfaces. The set of feet can be quickly and correctly positioned in any building site environment.

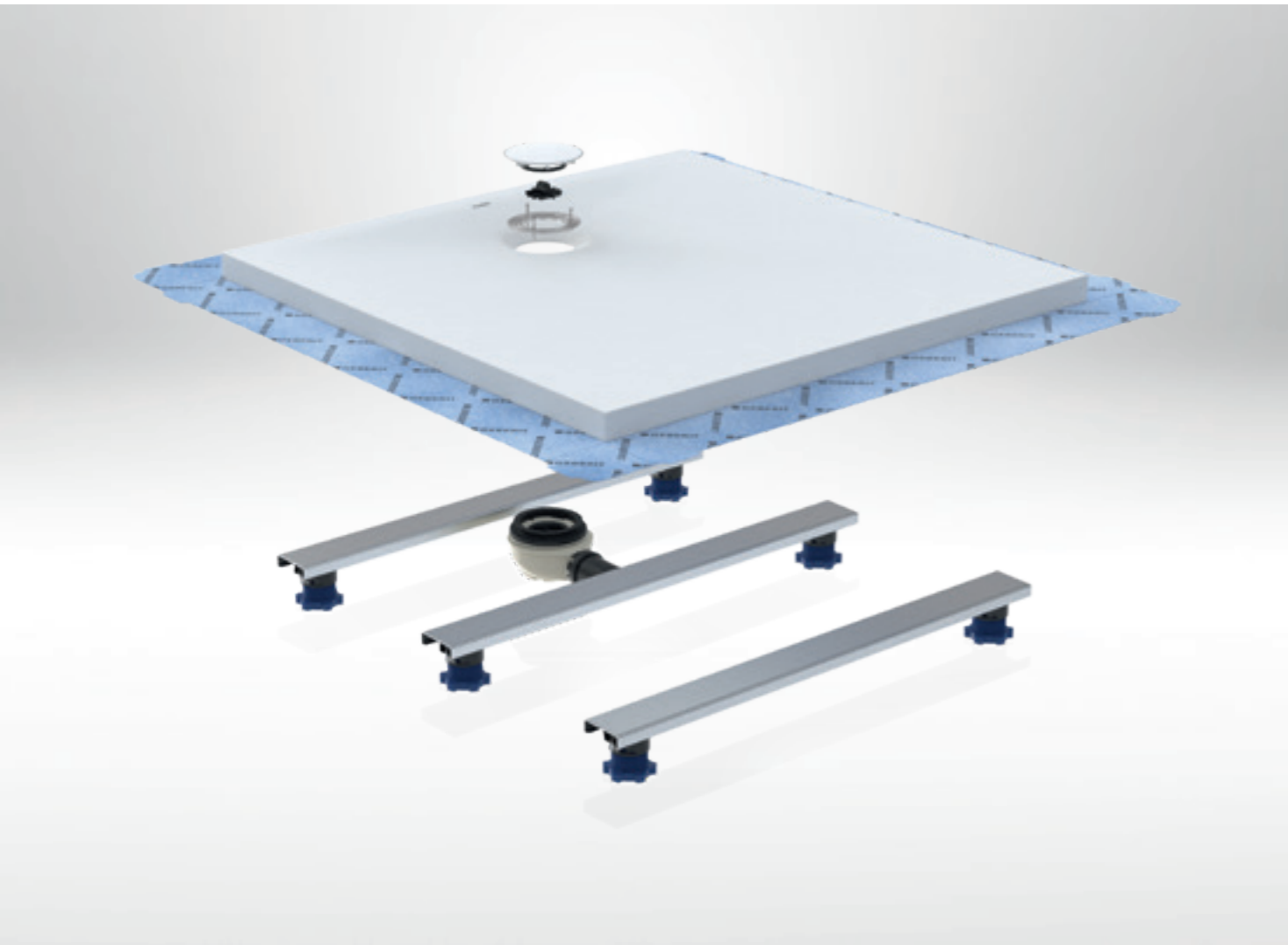

RAIL WITH ADHESIVE TAPE

The supporting crossbars are equipped with an adhesive surface for fastening to the bottom side of the shower surfaces.



RAIL PRESSED ONTO THE SHOWER TRAY FLOOR

After the protective foil is peeled off, the rail is bonded to the shower surface from below.



SET OF FEET IN THE RAIL

The set of feet is simply pushed into the rail and fixed by turning into place.



EASY ALIGNMENT

Tool-free height adjustment to adapt to the surface by turning the easy-to-grip blue adjusting screw.

GEBERIT NEMEA SHOWER SURFACE FLOOR-EVEN SHOWERS **FOR EVERY BATHROOM**

The Nemea shower surface offers a cost-effective, elegant solution for floor-even showers. The surface made of sanitary acrylic has a pleasantly warm feel, is easy to clean and resistant to ageing over the long term. It is available in high-gloss or matt white alpine, with the extra option of a cover in white with a chrome rim.



Silky-smooth surface that is pleasant and warm to the touch



Elegant shower surface made of reliable sanitary acrylic



Simple cleaning and care

- Elegant, affordable shower surface in many sizes
- Made of pleasantly warm acrylic in high-gloss or matt white alpine, easy to clean and resistant to ageing
- Comb insert in the drain
- Simple installation thanks to proven crossbar system with tool-free adjustment



EASIER CLEANING

The drain is equipped with a comb insert that prevents the trap from clogging and makes cleaning easy.

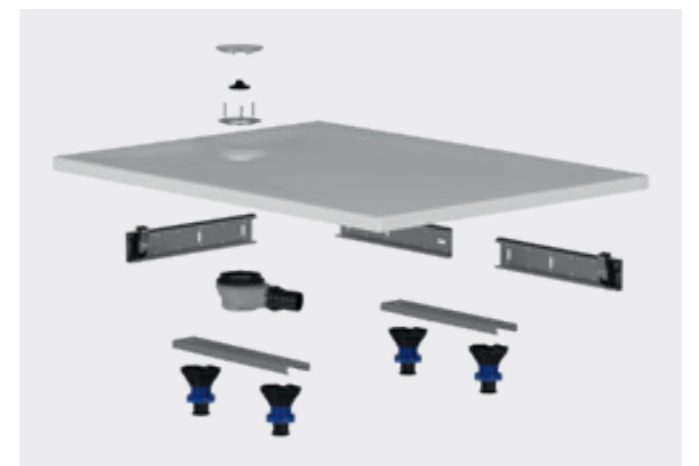

PROVEN CONSTRUCTION

The installation set consists of a shower tray, set of feet, crossbars, trap, drain cover and comb insert.

GEBERIT NEMEA IS AVAILABLE IN NINE DIFFERENT FORMATS

SQUARE DESIGN

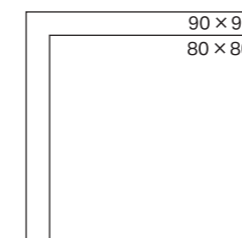

RECTANGULAR DESIGN

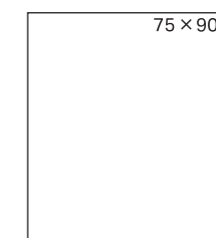
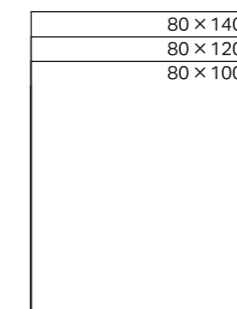
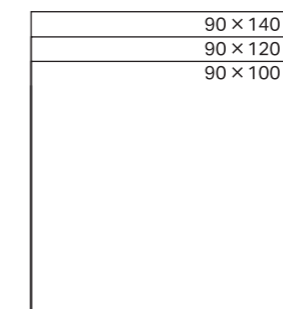

Geberit shower channels in the CleanLine series combine an elegant appearance with the easy installation of a floor drain. In addition, the innovative system solves the hygiene problem many shower channels have.



No hidden gutters means no chance of any dirt or bacteria deposits. The removable comb insert makes the drain easy to keep clean



Floor-even access for completely tiled shower areas



Classic stainless steel, on-trend in coloured metallic tones, discreet as a tile-bearing profile



NARROW AND FUNCTIONAL: THE NEW GEBERIT CLEANLINE50 SHOWER CHANNEL

With a width of just three centimetres, the CleanLine50 complements the range of Geberit CleanLine shower channels with a new design variant. Technically, the new CleanLine50 shower channel scores points with proven features: easy cleaning, guaranteed tightness and integrated slope. It is available in two colours and finishes: brushed stainless steel and black chrome with anti-fingerprint coating.

GEBERIT SHOWER CHANNEL IN THE CLEANLINE SERIES DESIGN SOLUTION IN THE FLOOR

- Extremely high customer satisfaction thanks to simple cleaning and modern linear appearance.
- Suitable for tiled and PUR flooring.
- Can be cut directly to the required length during installation.



DESIGNED FOR CLEANLINESS

The collector profile drains all traces of water and dirt. It can be kept clean by simply wiping it down. The comb insert in the drain traps hair to keep it out. This can be removed in no time and washed out with ease.



TILE-BEARING

The tile-bearing model of Geberit shower channels in the CleanLine series can be discreetly adapted to suit the floor tiles.

DESIGN OPTIONS TO SUIT ANY BATHROOM STYLE

The shower channel is available in various design options with three different shapes of stainless-steel profile: the Geberit CleanLine20, CleanLine60 and CleanLine80 shower channel. The new Geberit shower channel CleanLine80 features a high-quality, self-contained channel profile with an integrated slope and can be ordered in the on-trend metallic tones of champagne, black chrome and classic stainless steel.

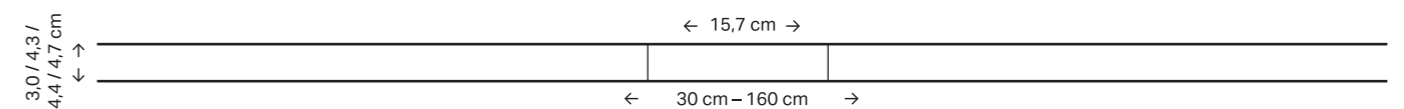

GEBERIT SHOWER CHANNEL IN THE CLEANLINE SERIES

- Easy access to the drain
- Suitable for installation centrally and close to the wall
- Classic and discreet linear design, suitable for virtually any floor—even shower area



- Unique design with cover profile, comb insert and drain
- Effortless installation thanks to complete installation kit
- Premounted sealing foil securely injected ex works for reliable sealing
- Length and positioning flexibly adjustable



TOP DESIGN MADE EASY

The timeless linear design of shower channels is equally popular with private and commercial bathroom customers. Geberit shower channels in the CleanLine series offer a whole host of additional benefits. They guide the water through an open cover profile to the drain in the middle. This means there are no hidden channel areas where dirt and odours can accumulate. At the same time, they are as easy to install as a floor drain thanks to their innovative technical structure. The profile can be integrated into the floor like a tile, which means even tilers can work with Geberit CleanLine without a hitch.

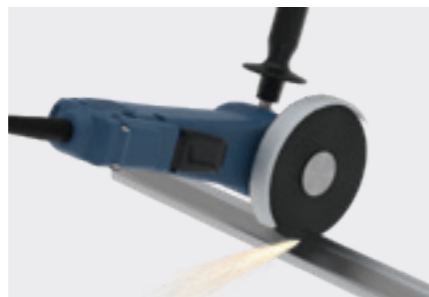

PRECISE

The Geberit shower channels in the CleanLine series can be individually cut to length directly during installation and adapted to the showering area. The various design options offer suitable solutions for every floor type. The shower channel can be positioned centrally in the shower or close to the wall.

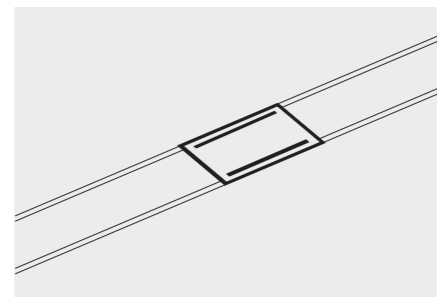

CONNECTING PIECES FOR COMMUNAL SHOWERS

Geberit offers connecting pieces designed to combine multiple shower channels for communal shower systems into a cohesive visual unit.



SOUND-DECOUPLED BASE UNIT

Certified compliance with sound insulation requirements. The trap is available for two different installation heights: minimum 6.5 cm or minimum 9 cm.



ADDITIONAL CONNECTION FOR THE WASHBASIN DRAIN

Installation set with lateral outlet for connection of a washbasin drain, rotatable by 360°



The Geberit wall drain permits floor-even showering in pure form. Integrated behind the wall, it is outstanding not only for its elegance but also for its clear added value in terms of planning, installation and maintenance.



Floor-even access for completely tiled shower areas



No interruption of the floor surface caused by the drain



Continuous tiling on the floor

GEBERIT WALL DRAIN

DESIGN SOLUTION BEHIND THE WALL

- Innovative solution for integration in prewall systems
- Clear separation of trades thanks to pipe placement behind the wall
- Optional collector profile for efficient and precise formation of the slope in the floor



FOR NEW CONSTRUCTION AND RENOVATION

The Geberit wall drain for showers is the answer customers have been waiting for when it comes to bringing their dream designs to life. Not only is it suitable for use in a wide range of applications, but the system technology allows wall drains to be installed in all bathrooms featuring a prewall installation system – even in renovations or where space is limited.

COLOURS/PRODUCT MATERIALS

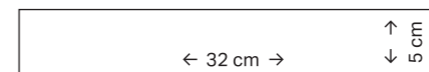

Stainless steel polished



Stainless steel brushed



Black matt



Bright chrome-plated

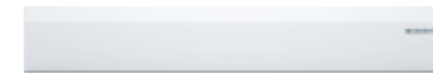

White alpine



Tiled according to preference



DEVELOPED FOR OPTIMUM HYGIENE

The Geberit wall drain for showers features an integrated comb insert that can be removed and washed out in no time at all. The cleaning of the shower floor is particularly simple thanks to the uninterrupted floor.



WELL-THOUGHT-OUT ALL DOWN THE LINE

The optionally installable collector profile directly in front of the wall supports the slope and collects dirt and deposits so that they can be readily washed away.

NEW



The Geberit floor drain is the universal solution for floor-even showers. It offers a number of clear benefits, including a minimalist design, ingenious functionality and easy installation.



Various design covers



Easy to clean thanks to integrated comb insert



Threshold-free access for floor-even shower areas

GEBERIT FLOOR DRAIN

SIMPLE AND COMPACT

- Intelligent details for an uncomplicated installation
- Design grating made of solid stainless steel
- Compact structure
- Reliable seal with sealing foil injected ex works

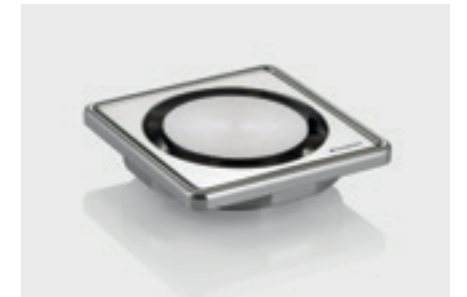

MAXIMUM REDUCTION AND PRECISION

The Geberit shower floor drain sets itself apart thanks to its extremely compact construction with a grating area of only 8 × 8 cm along with its exceptional functionality. The height, inclination and offset of the grating can be adjusted to suit the tile grid.

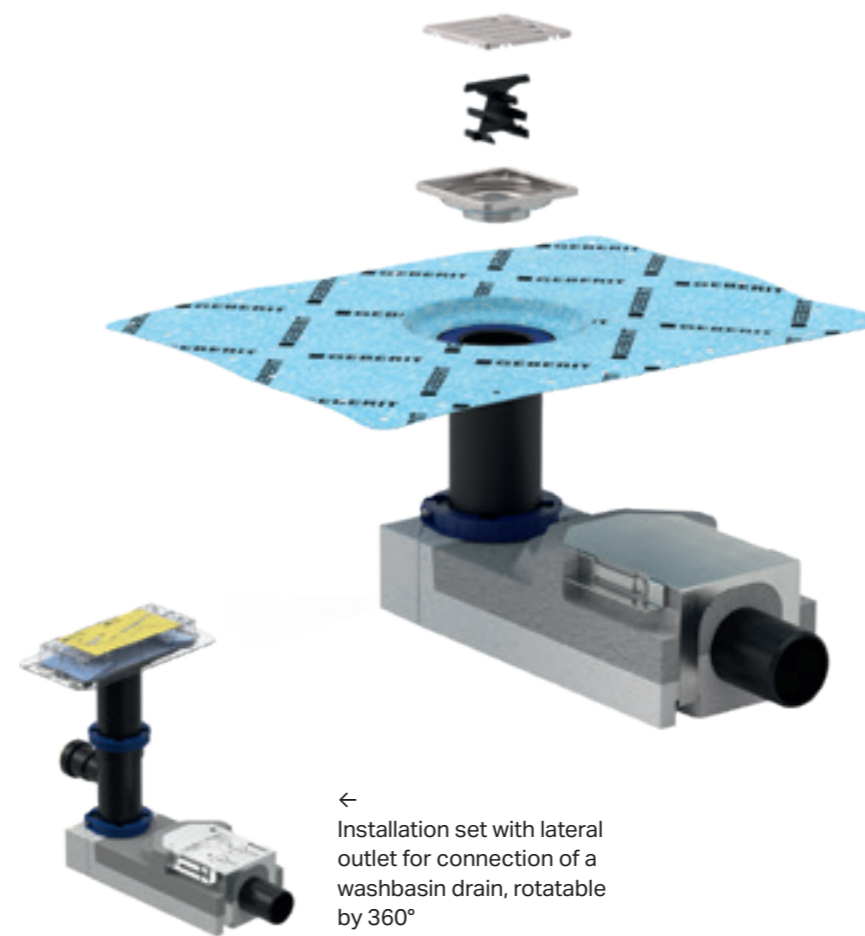

← Installation set with lateral outlet for connection of a washbasin drain, rotatable by 360°



ALWAYS A CLEAN DRAIN

Under the grating, there is an integrated comb insert that can be easily removed and washed out for cleaning. This prevents clogging in the drain and the discharge pipes.

BIG PERFORMANCE IN A SMALL PACKAGE

When installation needs to be as simple as possible and costs kept as low as they can be, the Geberit floor drain is the best solution – and a very compact one at that, with a grating area of only 8 × 8 cm. Hidden under the grating are the great qualities that make Geberit one of the world's leading providers of sanitary technology.

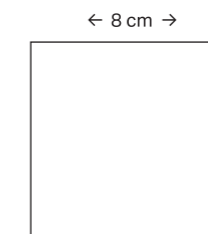

Stainless steel, round



Stainless steel, square



Consistent room design



Threshold-free access for floor-even shower areas



Easy to clean thanks to integrated comb insert

GEBERIT FLOOR DRAIN FOR FLOORING MADE OF VINYL (PVC)

- For public and semipublic area
- Suitable for various pipe dimensions and floor structure height
- The technical structure corresponds to that of Geberit's known floor drains with reliably high drainage capacity
- Quick and economical installation thanks to tool-free mounting of all required parts included in the complete scope of delivery



STRUCTURE

The structure matches that of Geberit's known floor drains. The drains are available in dimensions of d40, d50 and d56, and in various construction heights.



THE NEW GEBERIT FLOOR DRAIN is suitable for installation in shower areas in semipublic buildings or temporary sanitary rooms.



FLOOR DRAIN FOR VINYL (PVC) FLOORS
Quick and easy installation in rooms with floors laid in rolls, such as vinyl (PVC) or linoleum floors.



ALWAYS A CLEAN DRAIN
Under the grating, there is an integrated comb insert that can be easily removed and washed out for cleaning. This effectively prevents clogging in the drain and the discharge pipes.



The Geberit niche storage box offers shelf surfaces without restricting freedom of movement underneath the shower. It allows water to drain off at the front, thereby reliably preventing any build-up of residue.

The Geberit walk-in shower panel is fastened to the prewall without any visible fittings or profiles. This makes the surfaces even easier to clean.



No water or dirt residue in the niche storage box, as the water is able to drain freely from the shelf surface



Walk-in shower panel without bulky aluminium profiles



By using the prewall, the niche storage box creates additional storage space without restricting freedom of movement

GEBERIT NICHE STORAGE BOX & WALK-IN SHOWER PANEL **PREWALL** WITH CLEVER BENEFITS

- Integration of Geberit walk-in shower panel and niche storage box into the prewall system
- Geberit walk-in shower panel incorporated seamlessly into the planning and installation processes for prewall installation
- Quick and straightforward installation of the shower area



SPACE-SAVING AND EASY TO INSTALL

An installation set equipped with a pre-mounted sealing foil makes the Geberit niche storage box an integral component of the installation system. The ready-to-install Geberit niche storage box simplifies both planning and installation. What's more, this space-saving solution ensures there are no bottlenecks in connection with the shower tap.

EASY INSTALLATION WITHOUT FITTINGS

The Geberit walk-in shower panel can be integrated seamlessly into the planning and installation processes for the prewall system thanks to a newly developed installation element. The use of the prewall facilitates a large adjustable range for the glass pane of 5 cm.



The Geberit niche storage box is integrated directly into the prewall installation.

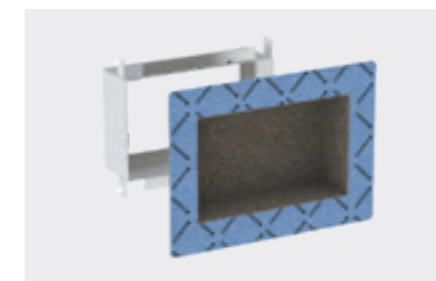

TILE-BEARING NICHE STORAGE BOX

The Geberit niche storage box is also optionally available as a tile-bearing model.



The Geberit walk-in shower panel is fastened in place without any visible fittings.



The Geberit bathtub drain with turn handle meets the desire for clear, minimalist bathroom designs. The new design and slim ergonomics offer an attractive solution for clear, minimalist and highly functional bathroom equipment.

GEBERIT BATHTUB DRAINS

THE ESSENCE OF BATHING

- Overflow and turn handle for the drain in one slim product
- Also available with a turn handle and integrated floor drain
- Elegant design variants and colours, suitable for every decor style
- Standardised installation of all drain assemblies



→ Hydraulically-optimised trap with low installation height in all bathtub drains.

→ Slim turn handle with clear look. The waste plug can be lifted or lowered with cable actuator by turning the actuator rosette.

RELIABLE DRAINAGE FOR EVERY BATHTUB DESIGN

The Geberit drain assembly for bathtubs is available in different designs depending on the type of installation: It comprises a drain with valve seat, a flexible overflow pipe and a trap that is connected to the floor drainage system. In addition, there is a cable actuator between the turn handle and the drain that can be used to lift or lower the waste plug by turning the actuator

rosette. The bathtub drain is also available with an integrated inlet for premixed water. The hidden floor drain has been flow-optimised and is easy to descale because the tap aerator is manually removable. A universal Masterfix bend connector connects it to the water supply line. With pressure-resistant sealing, the entire system from the mixer tap to the inlet can be subjected to a pressure test of up to 15 bar.



ATTRACTIVE SOLUTION
Bathtub drain with integrated inlet available for premixed water.

COLOUR VARIANTS



Chrome

White

White with chrome rim

Opaque black

Geberit Prodaja
d.o.o. Bezena 55a
2342 Ruše

www.geberit.al

